

# SSV KIT - Signature Light 715003673

Part number (SKU) : 715003673

Product:	Side-by-side
Project no:	487802171
Instruction Sheet P/N:	487802171
Revision no:	
Revision date:	
Item covered:	Signature Light (Kit P/N : 715003673)

The following symbols may be used in this document:

## WARNING

Indicates a hazardous situation which, if not avoided, could result in death or serious injury.

**CAUTION:** Indicates a hazard situation which, if not avoided, could result in minor or moderate injury.

**NOTICE** Indicates an instruction which, if not followed, could severely damage vehicle components or other property.

## WARNING

- This kit is designed for specific applicable models only (authorized BRP dealers will confirm model(s)). It is not recommended for units other than the one (those) for which it was sold.
- If the installation of the kit requires a template, ensure template is to scale.
- Should removal of a locking device (e.g. lock tabs, self-locking fasteners, etc.) be required when undergoing disassembly/assembly, always replace with a new one.
- Torque wrench tightening specifications must strictly be adhered to.

**NOTE:** USE TIGHTENING TORQUES IN THE FOLLOWING TABLE IF NOT OTHERWISE SPECIFIED. YOU CAN ALSO REFER TO SHOP MANUAL.



	GRADE			
	5.8	8.8	10.9	12.9
M4	1.8 ± 0.2 N•m (16 ± 2 lbf•in)	2.8 ± 0.2 N•m (25 ± 2 lbf•in)	3.8 ± 0.2 N•m (34 ± 2 lbf•in)	4.5 ± 0.5 N•m (40 ± 4 lbf•in)
M5	3.3 ± 0.2 N•m (29 ± 2 lbf•in)	5 ± 0.5 N•m (44 ± 4 lbf•in)	7.8 ± 0.7 N•m (69 ± 6 lbf•in)	9 ± 1 N•m (80 ± 9 lbf•in)
M6	7.5 ± 1 N•m (66 ± 9 lbf•in)	10 ± 2 N•m (89 ± 18 lbf•in)	12.8 ± 2.2 N•m (113 ± 19 lbf•in)	16 ± 2 N•m (142 ± 18 lbf•in)
M8	15.3 ± 1.7 N•m (135 ± 15 lbf•in)	24.5 ± 3.5 N•m (18 ± 3 lbf•ft)	31.5 ± 3.5 N•m (23 ± 3 lbf•ft)	40 ± 5 N•m (30 ± 4 lbf•ft)
M10	29 ± 3 N•m (21 ± 2 lbf•ft)	48 ± 6 N•m (35 ± 4 lbf•ft)	61 ± 9 N•m (45 ± 7 lbf•ft)	73 ± 7 N•m (54 ± 5 lbf•ft)
M12	52 ± 6 N•m (38 ± 4 lbf•ft)	85 ± 10 N•m (63 ± 7 lbf•ft)	105 ± 15 N•m (77 ± 11 lbf•ft)	128 ± 17 N•m (94 ± 13 lbf•ft)
M14	85 ± 10 N•m (63 ± 7 lbf•ft)	135 ± 15 N•m (100 ± 11 lbf•ft)	170 ± 20 N•m (125 ± 15 lbf•ft)	200 ± 25 N•m (148 ± 18 lbf•ft)
M16	126 ± 14 N•m (93 ± 10 lbf•ft)	205 ± 25 N•m (151 ± 18 lbf•ft)	255 ± 30 N•m (188 ± 22 lbf•ft)	305 ± 35 N•m (225 ± 26 lbf•ft)
M18	170 ± 20 N•m (125 ± 15 lbf•ft)	273 ± 32 N•m (201 ± 24 lbf•ft)	330 ± 25 N•m (243 ± 18 lbf•ft)	413 ± 47 N•m (305 ± 35 lbf•ft)

The illustrations in this document show typical construction of the different assemblies and may not reproduce the full detail or exact shape of the parts; however, they represent parts that have the same or similar function.

In the pictures below, parts may have been removed for clarity purposes.

Installation time is approximately 1 hour.

## ICON LEGEND

Icon	indicates
	Parts Kept for Reinstallation
	Parts to be Discarded

## INSTRUCTIONS

### Item in Kit

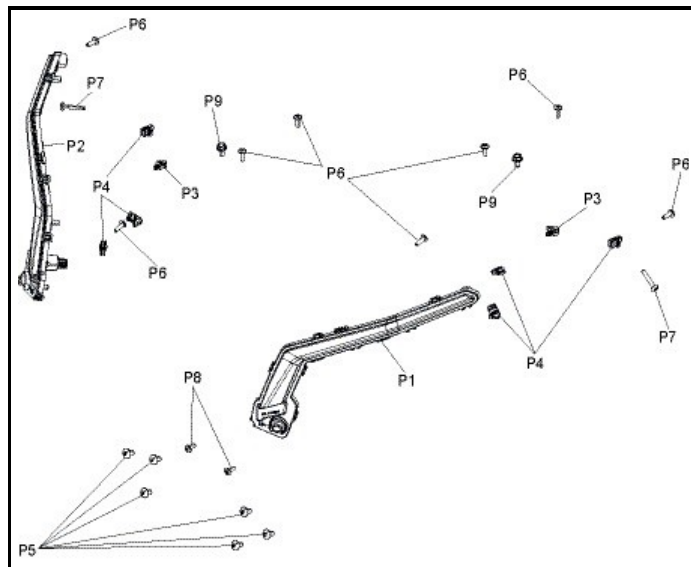

Item	Description	Part Number	QTY
P1	LH Signature Light	710004994	1
P2	RH Signature Light	710004995	1
P3	Tie-Rap Christmas Tree	710005237	2
P4	Tie-Rap Clip	710002889	6
P5	Torx Truss Screw M8 x 16	250000746	6
P6	Torx Truss Screw M6 x 20	250000722	8
P7	Torx Truss Screw M6 x 45	250000748	2
P8	Torx Truss Screw M6 x 20	250000721	2
P9	Hex. Flanged Screw M8 x 16, S. Grip	207581644	2

### Signature Light Installation

1. Remove and discard the screws. They will be replaced with item [P5] (Grade 8.8).

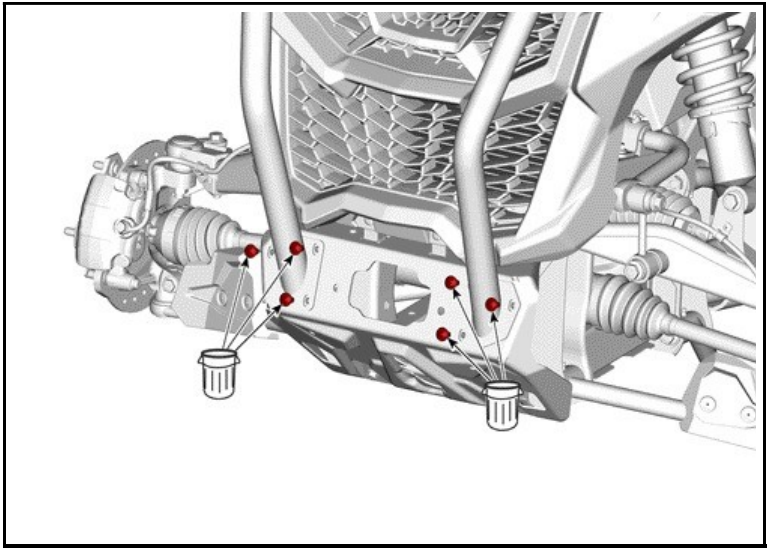

2. Remove and discard the screws. They will be replaced with item [P6]. Remove and keep both support plates and washers.

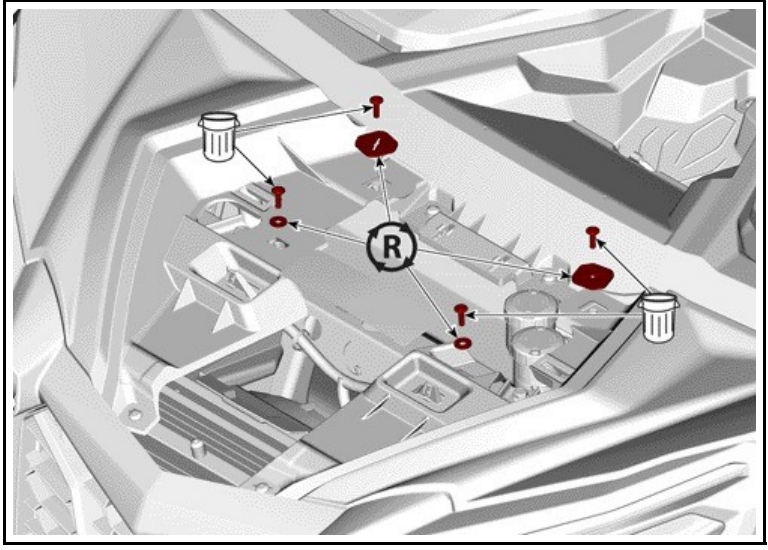

tightening torque	
Torx Truss Screw M6 x 20 [P6]	2.5 ± 0.5 N•m (22 ± 4 lbf•in)

3. Remove and discard the screws. They will be replaced with item [P7].

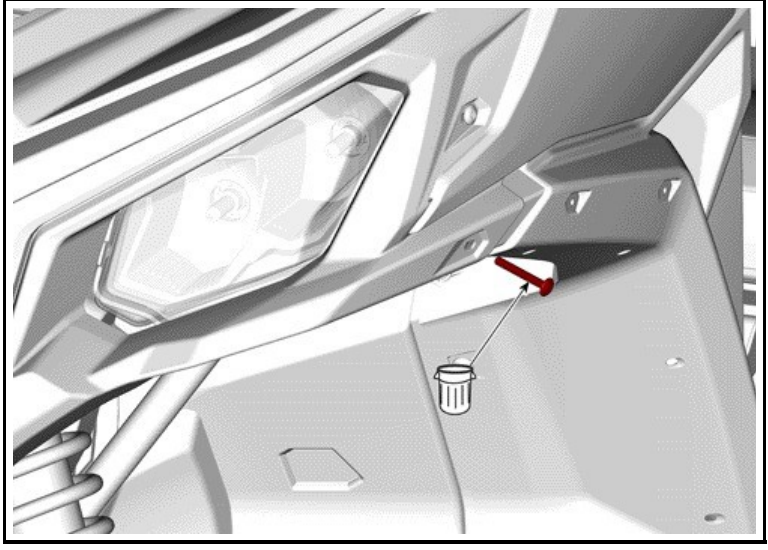

tightening torque	
Torx Truss Screw M6 x 45 [P7]	2.5 ± 0.5 N•m (22 ± 4 lbf•in)

4. Remove and discard the screws. They will be replaced with item [P8].

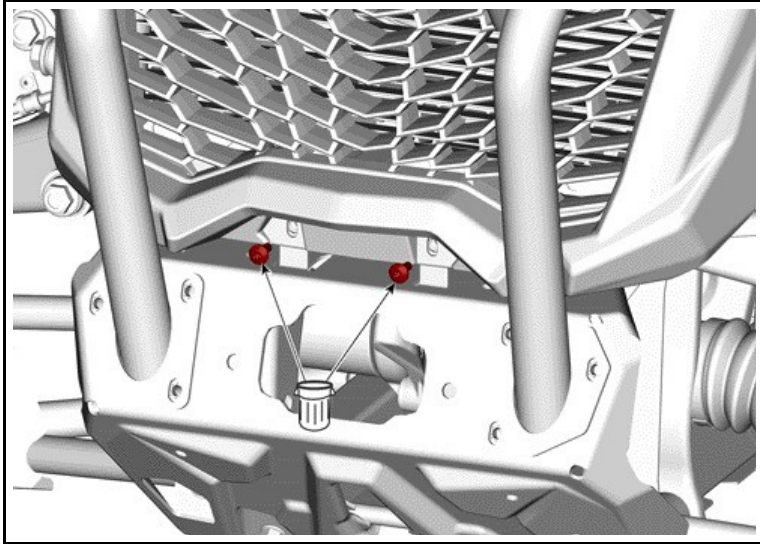

tightening torque	
Torx Truss Screw M6 x 20 [P8]	2.5 ± 0.5 N•m (22 ± 4 lbf•in)

5. Cut 4 locking ties on both sides of the vehicle.

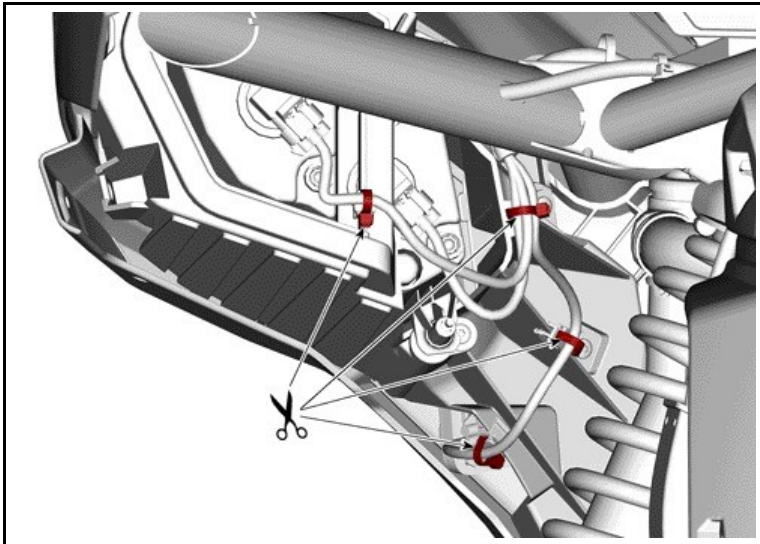

6. Disconnect the 3 cables on both sides for the High lights, low lights and Signature Lights).



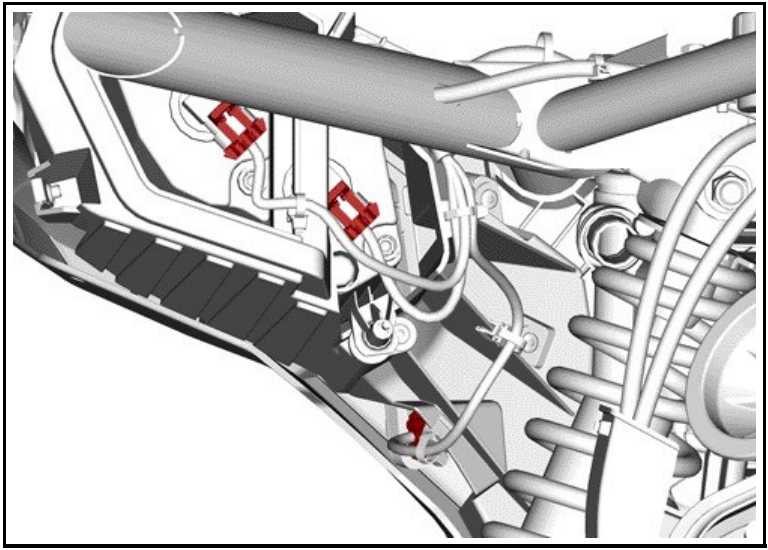

7. Remove and discard the screws. They will be replaced with item [P9] (Grade 8.8).

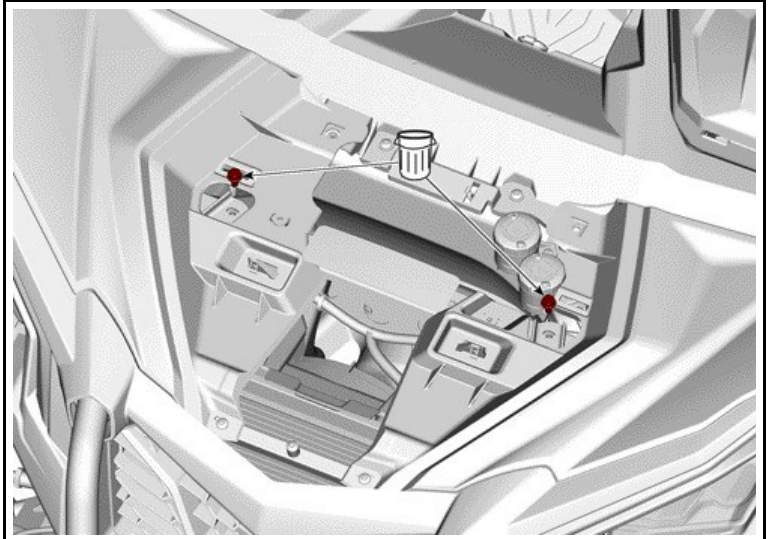

8. Remove Sub assembly.



9. Remove and discard the screws. They will be replaced with item [P6].

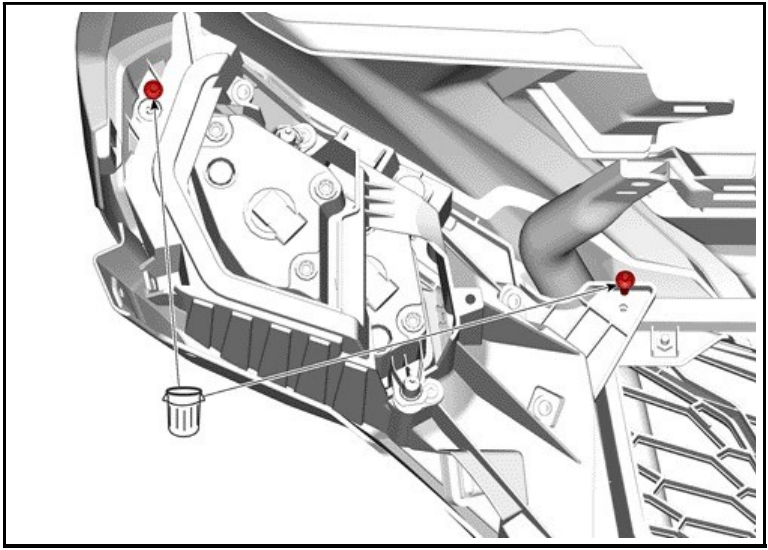

tightening torque	
Torx Truss Screw M6 x 20 [P6]	$2.5 \pm 0.5 \text{ N}\cdot\text{m}$ ( $22 \pm 4 \text{ lbf}\cdot\text{in}$ )

10. Remove and keep screws and washers.

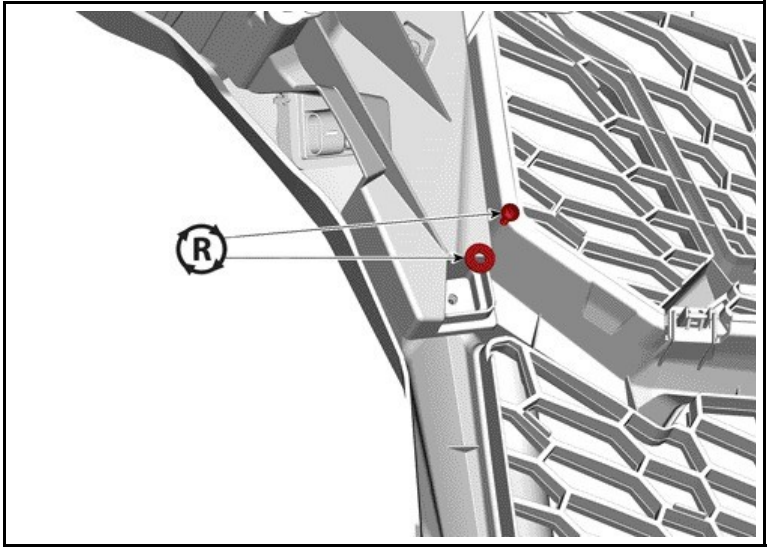

11. Remove and keep screws and washers.

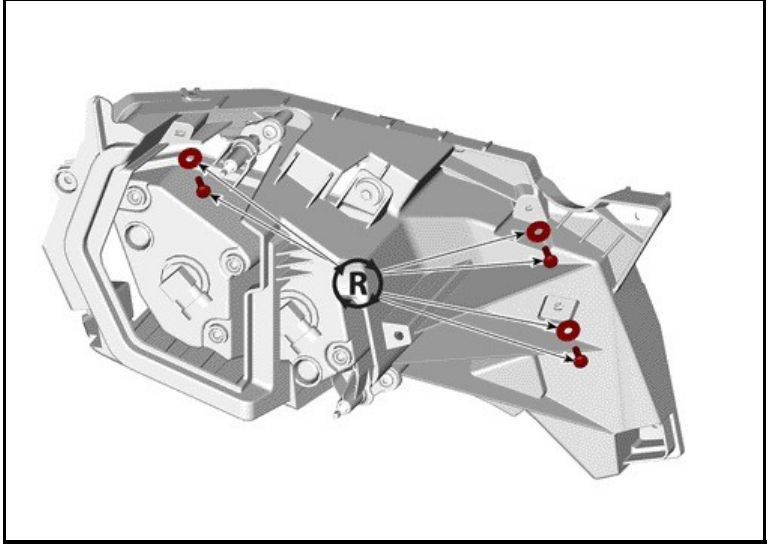

12. Remove Fascia Trims.

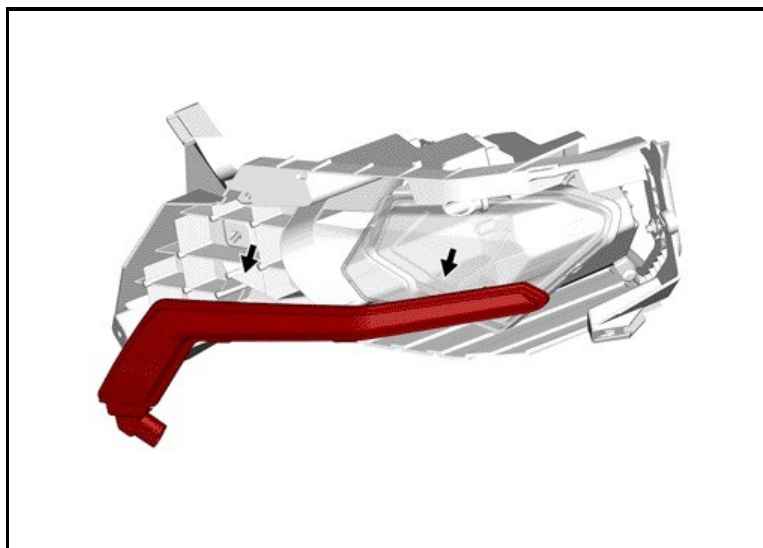

13. Install Signature Light.

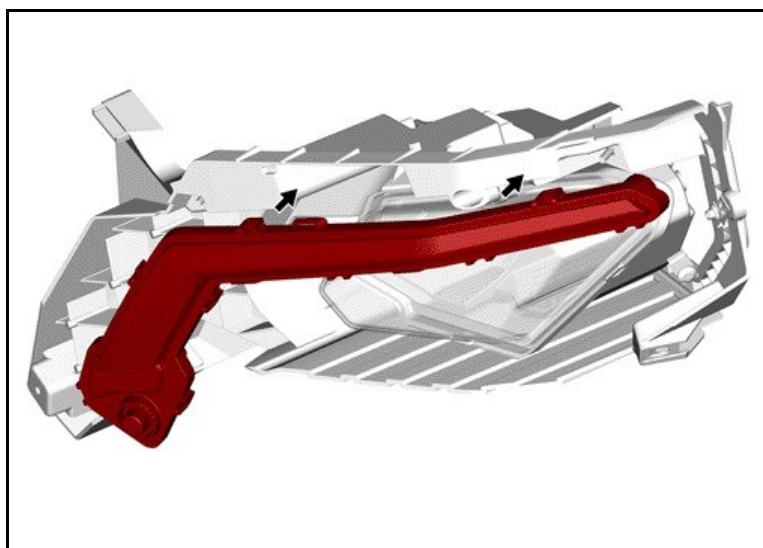

14. Apply torque shown in chart.

15. Connect connector to the light.

16. Install parts in the reverse order of removal.